

# RIFLET

## Pendant Lamp

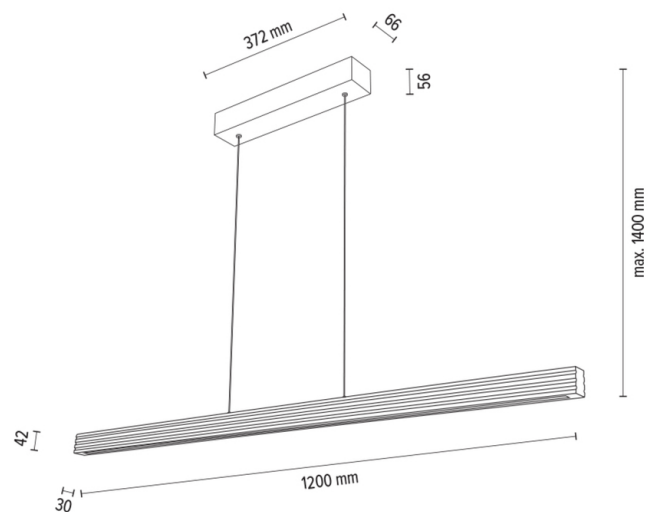

Article number:	1037422900000
EAN:	5905840262548
Light source:	3x LED 24V Integrated
LED power W:	28W
AC voltage:	220-240V
Luminous power lm:	2224 lm
Color temperature K:	3000K
Color rendering index CRI:	CRI ≥ 80
IP protection class:	IP20
Protection class:	2
Up&Down system:	YES
Touch dimmer:	YES
Click&Dimm system:	N/A
Magnetic mounting:	N/A
LED lighting method:	Direct & Indirect LED lighting
Lamp material:	Metal, Oak wood
Lamp color:	Nickel Matt, Oiled Oak
Lampshade No.:	N/A
Lampshade material:	N/A
Lampshade color:	N/A
Cable material:	Metal/PVC
Cable color:	Metal/Transparent
CE Declaration:	<a href="#">Download</a>
FSC certificate:	<a href="#">FSC-C129231</a>
Lamp dimensions	
Height (mm):	1400
Width (mm):	66
Length (mm):	1200
Diameter (mm):	
Net weight kg:	2,10
Gross weight kg:	2,52
Dimensions of carton No.1	
Height (mm):	140
Width (mm):	160
Length (mm):	1240
Dimensions of carton No.2	
Height (mm):	n/a
Width (mm):	n/a
Length (mm):	n/a
Dimensions of carton No.3	
Height (mm):	n/a
Width (mm):	n/a
Length (mm):	n/a



Made in Poland · 5 Years Guarantee